

| | | |
|------|-------------|------------|
| REV. | ECN.NO. | APPD. |
| A | EXXXXXXXXXX | chenyiting |

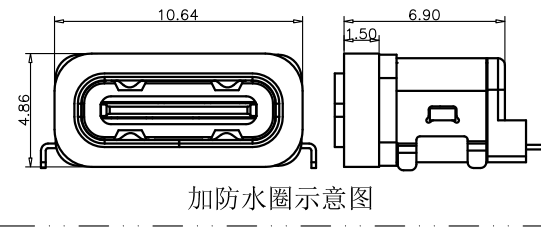

加防水圈示意图

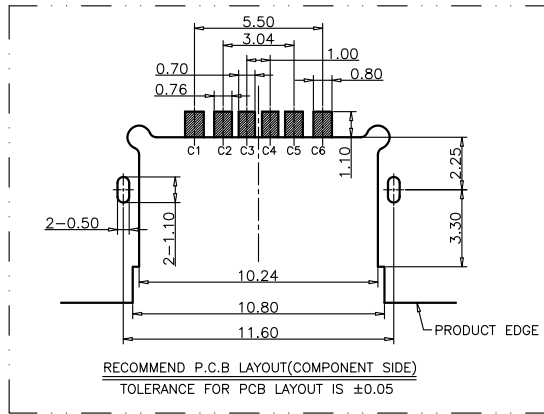
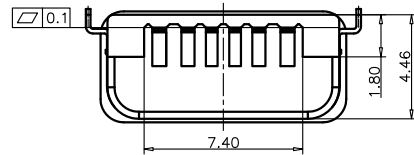
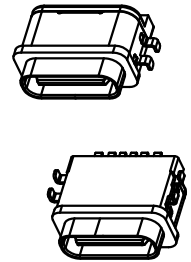

- NOTES:
- MATERIAL:
 - Housing:thermoplastic plastics
 - terminals:Copper Alloy
 - Gold plated in contact area:
Tin plated in termination
Nickel Plated overall
 - Shell:Steel&Copper Alloy
Nickel/Au Plated overall
 - characteristics:
 - Rating Voltage : 30V AC.
 - Rating Current:
5A for Vbus PIN;1.25A for Vconn PIN
 - Contact Resistance:40 mΩ MAX.
 - Insulation Resistance:100 MΩ MIN.
 - Withstanding Voltage:AC 100V
 - Mating force: 5~20N MAX
 - Extraction force:8~20N Min
 - Life test:10000Cycles MIN.
 - Temperature Range: -30℃~+80℃.
- The product must be compliance ROHS

U573-541B-G61038

- B: 不锈钢壳镀镍
- G: 半金G/Fu
- 3: 载带
- 1: 黑色
- 6: LCP

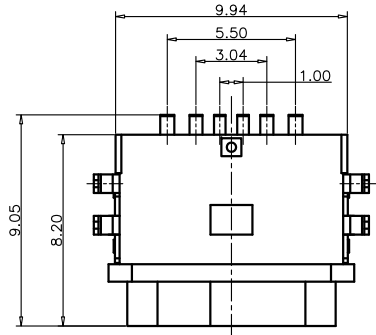
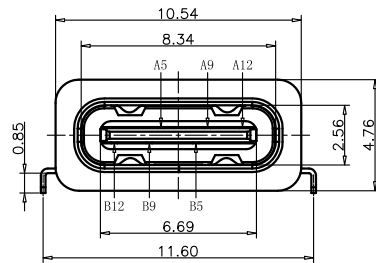
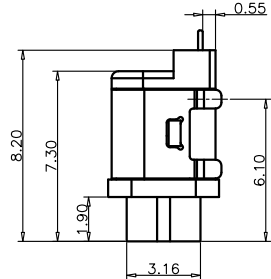
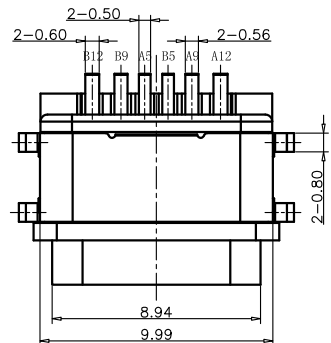

PIN ASSIGNMENT:

| PIN NO | A1&B12 | A4&B9 | A5 | B5 | A9&B4 | A12&B1 |
|-------------|--------|-------|-----|-----|-------|--------|
| SIGNAL NAME | GND | VBUS | CC1 | CC2 | VBUS | GND |
| PCB PAD NO. | C1 | C2 | C3 | C4 | C5 | C6 |

| | | | | | | |
|--------------------------------------|------------|---------------------------------------------------------------|------------------|----------------------|-------|------|
| TOLERANCE UNLESS OTHERWISE SPECIFIED | | 深圳市华联威电子科技有限公司 HUA LIAN WEI TECHNOLOGY ELECTRONICS CO;LTD. | | | | |
| .XXX ±0.10 | .X' ±3' | | | | | |
| .XX ±0.20 | .XX' ±2' | | | | | |
| .X ±0.30 | | APPROVED | PART NAME: | TYPE C 6P/F 防水沉板 两脚插 | | |
| CHECKED | | PART No: | U573-541B-G61038 | | | C |
| DRAWN | chenyiting | PROJECTION: | UNIT: | SCALE | SHEET | REV. |
| DATE | 2023.04.12 | | mm | 1:1 | 10F1 | A |