

REV.	ECN.NO.	APPD.
A	XXXXXXXXXX	yangguifeng

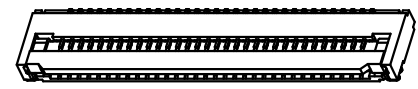

- Specifications:
1. Rated Voltage : 125V AC/DC
 2. Rated Current : 1A AC,DC
 3. Withstand Voltage : 200V AC/minute
 4. Contact Resistance : 50mΩ(MAX.)
 5. Insulation Resistance : 100MΩ(MIN.)
 6. Storage Temperature Range: -40°C~+85°C;
 7. Operation Temperature Range: -25°C~+70°C;

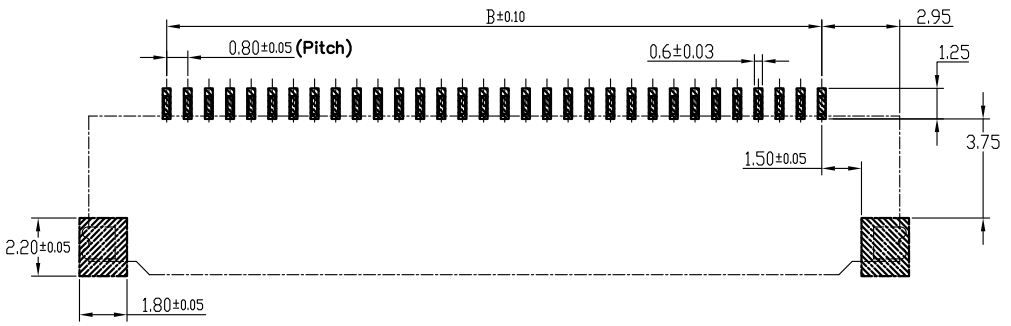
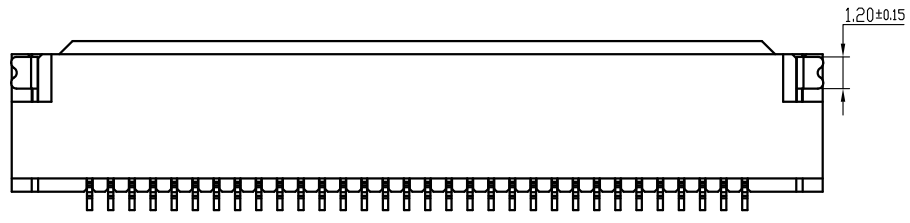
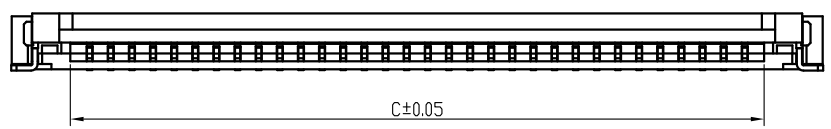
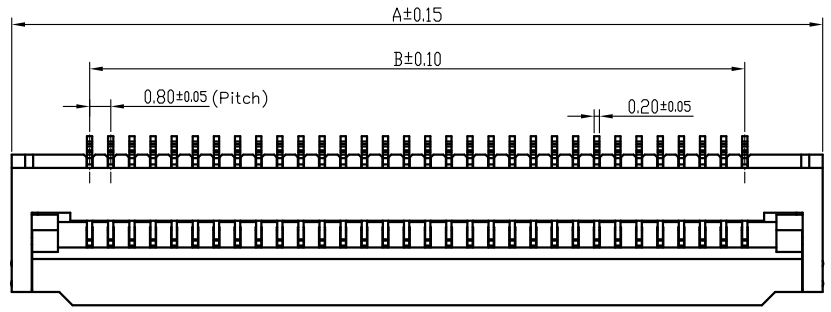
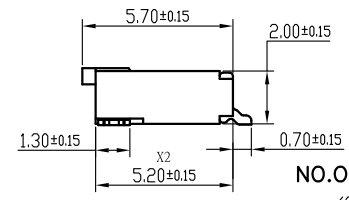

216104-1091-G63018
 G: 半金G/Fu 1: 吸塑盒
 6: LCP 3: 米黄色

NO.OF CONTACTS:(04Pin~60Pin)

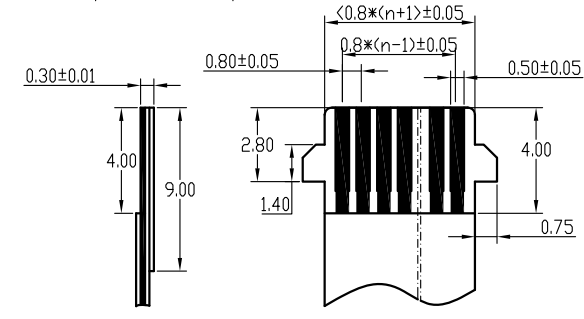

APPLICABLE FPC

No. of Contacts	DIM.		
	A	B	C
12	14.70	8.80	10.45
28	27.50	21.60	23.25
30	29.10	23.20	24.85
32	30.70	24.80	26.45
36	33.90	28.00	29.65

TOLERANCE UNLESS OTHERWISE SPECIFIED	
.XXX ±0.10	.X ±3'
.XX ±0.20	.XX ±2'
.X ±0.30	

FLW 深圳市华联威电子科技有限公司
 HUA LIAN WEI TECHNOLOGY ELECTRONICS CO;LTD.

APPROVED		PART NAME:	FPC 高度2.0间距0.8 32PIN			
CHECKED		PART No:	216104-1091-G63018	C		
DRAWN	yangguifeng	PROJECTION:	UNIT:	SCALE	SHEET	REV.
DATE	2021.12.01		mm	1:1	1 OF 1	A